

## TELESCOPING POLE MOUNTS

### STANDARD POLE SPECS FOR 100-600 AND 800 SERIES

- Anodized aluminum pole with a 320 grit spiral bright dipped finish
- Kwik-release latch on a reinforced white Xenoy® thermal plastic resin clamp with a lifetime warranty
- 1.38" OD inner pole / 1.88" OD outer pole
- 3/4" bushing and swivel for mounting light fixtures

### Top-Raising Poles

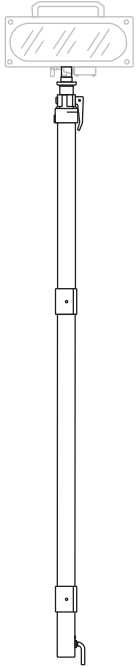

#### 100 Series Flush Mount

- Two cast aluminum flush mounting

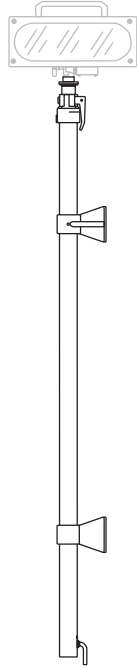

#### 200 Series Side Mount

- Specify 2", 4", or 7" offset
- Two cast aluminum offset mounting brackets

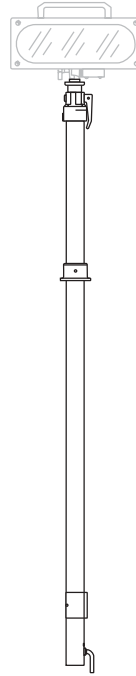

#### 300 Series Thru Body Mount

- Two cast aluminum mounting brackets, one thru body and one flush mount

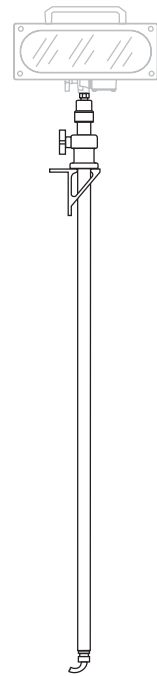

#### 900 Series Economy Thru Body Mount

- Top raise telescoping economy pole with thru-body mounting flange
- 16/3 ga. concealed cord, 4' length
- Heavy wall 1" OD anodized aluminum pole with 320 grit spiral bright-dipped finish

All (except the 900 series) top raise poles come standard with the following:

- Two cast aluminum mounting brackets
- 48" inner telescoping pole, 58" outer pole standard
- Concealed coil cord standard
- Switch optional



900 Series Option Corner Mount  
 CD-OSB-1

**\*\*See page L5 -L8 for available lightheads for these mounts\*\***

### Mounting Brackets Available

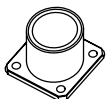

Thru-Body Mount Bracket  
 KR-3-18

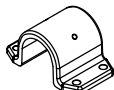

Flush Mount Bracket  
 KR-1-18

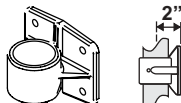

2" Offset Bracket  
 KR-2-OMB

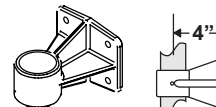

4" Offset Bracket  
 KR-4-OMB

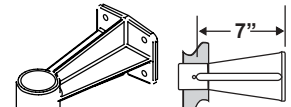

7" Offset Bracket  
 KR-7-OMB

See additional Kwik-Raze options on page L15

Contact us @

Ph: 800.524.9900 or 215.957.0720  
 E-mail: sales@havis.com

Fax: 215.957.0729  
 Web: <http://www.havis.com>

**TELESCOPING POLE MOUNTS**

**STANDARD POLE SPECS FOR 100-600 AND 800 SERIES**

- Anodized aluminum pole with a 320 grit spiral bright dipped finish
- Kwik-release latch on a reinforced white Xenoy® thermal plastic resin clamp with a lifetime warranty
- 1.38" OD inner pole / 1.88" OD outer pole
- 3/4" bushing and swivel for mounting light fixtures

**Bottom-Raising Poles**

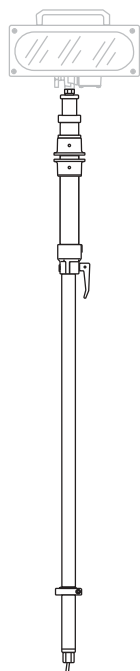

**400 Series Thru body Mount**

- 48" inner telescoping pole, 12" outer pole standard
- Two cast aluminum thru-body mounting brackets

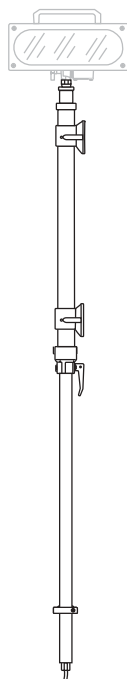

**500 Series Side Mount**

- Specify 2", 4" or 7" offset
- 67.5" inner telescoping pole, 24" outer pole standard
- Two cast aluminum offset mounting brackets

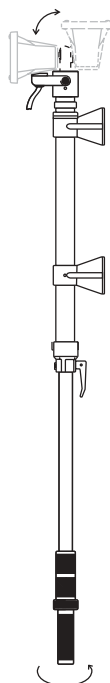

**1100 Series Remote Bottom Raise 4" or 7" Side Mount**

- Two cast aluminum 4" or 7" offset mounting brackets (specify W/4 for 4" brackets or W/7 for 7" brackets)
- 67.5" inner telescoping pole, 24" outer pole standard

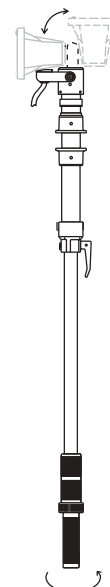

**1200 Series Remote Bottom Raise Thru-Body Mount**

- Two cast aluminum thru body mounting brackets.
- 48" inner telescoping pole, 12" outer pole standard

All bottom raise poles come standard with the following:

- Two cast aluminum mounting brackets
- Concealed wire standard
- Optional lighthouse switch

Remote Pole Specs for 1100 and 1200 Series

- Poles are bottom-raising with a knurled handle adjustment
- Anodized aluminum pole with a 320-grit spiral bright dipped finish
- Available with Magnafire 31, 33, 36, 37, 39 fixtures only
- Not available with concealed wire or switch

\*\*See page L5 -L8 for available lighthoods for these mounts\*

**Mounting Brackets Available**

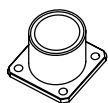

Thru-Body Mount Bracket  
**KR-3-18**

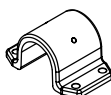

Flush Mount Bracket  
**KR-1-18**

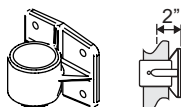

2" Offset Bracket  
**KR-2-OMB**

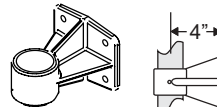

4" Offset Bracket  
**KR-4-OMB**

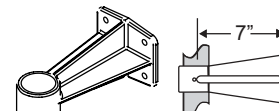

7" Offset Bracket  
**KR-7-OMB**

See additional Kwik-Raze options on page L15

Kwik-Raze® Lighthoods

Kwik-Raze® Poles & Mounts

Collins Dynamics® Lights

Contact us @

PORTABLE/TRIPOD MOUNTS

Portable Tripod: Telescoping

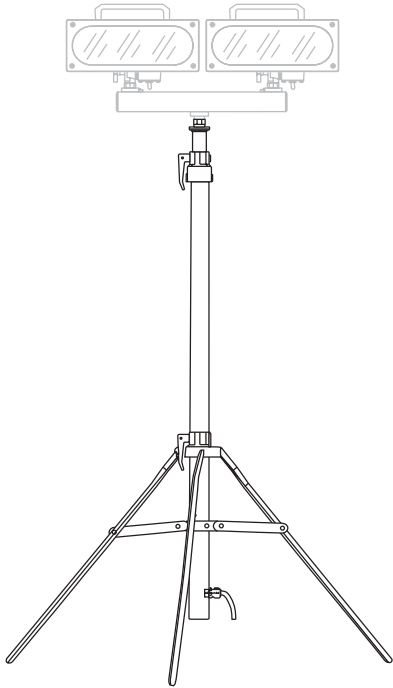

**800 Series  
 Top Raise Telescoping Tripod**

- On/ off switch standard
- Optional truck mount assembly (specify "TM" or "TM-7")
- Optional plugs available

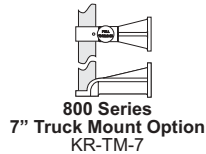

- All top raise poles come standard with the following:
- 48" inner telescoping pole, 58" outer pole standard
  - Concealed coil cord
  - Special lengths are available

- Anodized aluminum pole with a 320 grit spiral bright dipped finish
- Kwik-release latch on a reinforced white Xenoy® thermal plastic resin clamp with a lifetime warranty
- 1.38" OD inner pole / 1.88" OD outer pole
- 3/4" bushing and swivel for mounting light fixtures

Portable/Tripod

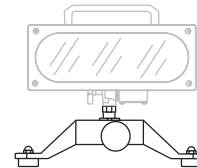

**700 Series Portable**

- Cast aluminum portable base
- 30" straight power cord standard (with Halogen & Magnafire lights KR-33, 36, 37, and 39)
- 9 ft. 16/2 coil cord with cigarette plug (Magnafire H.I.D KR-31)
- On/ off switch standard
- Optional kwik-release hold down assembly (specify "HD")
- Optional plugs available

\*\*See page L5 -L8 for available lighthoods for these mounts\*\*

Kwik-Raze® Lighthoods

Kwik-Raze® Poles & Mounts

Collins Dynamics® Lights

Contact us @

**RECESSED BODY MOUNTS**

(available for Magnafire 3000® lights only- see available lights on chart below)

**Available Magnafire 3000® Lighthoods for Recessed Body Mounts**

Recessed Mount	Recessed Depth	Light Angle Position	Available Lighthoods				
			KR-31	KR-33	KR-36	KR-37	KR-39
1800	2.5"	0° horizontal	KR-1831	KR-1833	KR-1836	KR-1837	KR-1839
1900	2.5"	10° downward	KR-1931	KR-1933	KR-1936	KR-1937	KR-1939
2100	2"	10° downward	KR-2131	KR-2133	KR-2136	KR-2137	KR-2139
2200	5.5"	0° horizontal	KR-2231	KR-2233	KR-2236	KR-2237	KR-2239
2300	5.5"	10° downward	KR-2331	KR-2333	KR-2336	KR-2337	KR-2339

**CUSTOM CAB BROW MOUNTS™ (1500 Series)**

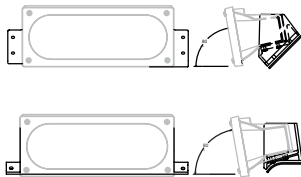

- Custom Brow Mounts™ available- Contact your firetruck manufacturer/OEM for availability
- Cast aluminum housing with light fixture positioned at 10° downward angle
- Relamps from the front of fixture



**1800 SERIES 2.5" RECESSED MOUNT**

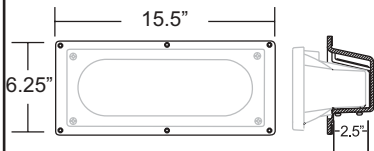

- Cast aluminum polished housing with light fixture positioned at 0° horizontal angle
- Requires 14.25" x 5" cutout for in-body mounting
- Recessed depth is 2.5"
- Relamps from the front of fixture



**1900 SERIES 2.5" RECESSED MOUNT**

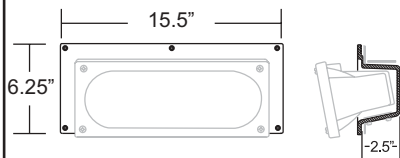

- Cast aluminum polished housing with light fixture positioned at 10° downward angle
- Requires 14.25" x 5" cutout for in-body mounting
- Relamps from the front of fixture



**2100 SERIES 2" RECESSED MOUNT**

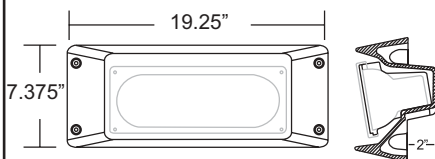

- Cast aluminum polished housing with light fixture positioned at 10° downward angle
- Housing designed to protect the light fixture
- Requires 14" x 4.5" cutout for in-body mounting, recessed depth is only 2"
- Relamps from the front of fixture



Contact us @

**RECESSED BODY MOUNTS** (continued)  
 (available for Magnafire 3000® lights only- see available models on previous page)

**2200 SERIES 5.5" FLUSH RECESSED MOUNT**

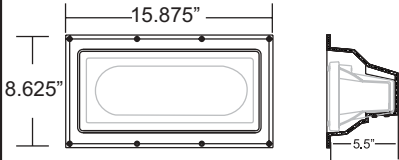

- Cast aluminum polished housing with light fixture positioned at **0° horizontal angle**
- Requires 15.5" x 7" cutout for in-body mounting
- Relamps from the front of fixture



**2300 SERIES 5.5" RECESSED MOUNT**

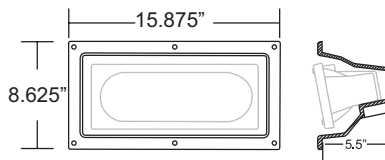

- Cast aluminum polished housing with light fixture positioned at **10° downward angle**
- Requires 15.5" x 7" cutout for in-body mounting
- Relamps from the front of fixture



**NON-TELESCOPING MOUNTS**

**600 SERIES PERMANENT MOUNT**

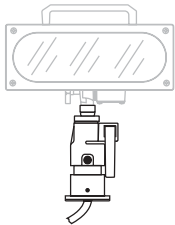

- One cast aluminum thru body mounting bracket
- Concealed wire standard (36" length)
- Switch optional



**1300 SERIES LOW CLEARANCE PERMANENT MOUNT**

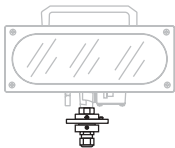

- 3.13" square base plate
- 358° horizontal rotation and 180° vertical tilt
- Switch optional



**1400 SERIES PLATFORM MOUNT**



- Permanently mounted angle brackets
- 90° vertical tilt adjustment
- On/off switch not available

